

Series PR precision regulators with manual override

Size 1 ports: G1/4
Size 2 ports: G1/4, G3/8



- » High precision adjustment
- » Multi-diaphragm construction to reach the highest stability
- » Adjustment lock
- » Compact dimensions
- » Removable adjustment knob

The Series PR precision pressure regulators are ideal for applications that require a precise and stable air pressure control. The operating principle using multiple diaphragms allows the Series PR to react to even the smallest pressure variations that may occur during use.

GENERAL DATA

Construction	compact, multi-diaphragm type
Materials	see the following page
Ports	Size 1: G1/4 Size 2: G1/4, G3/8
Mounting	vertical in-line, wall or panel mounting (in any position)
Working temperature	0°C ÷ 50°C
Inlet pressure	0.1 ÷ 12 bar
Outlet pressure	0.05 ÷ 2 bar 0.05 ÷ 4 bar 0.05 ÷ 7 bar 0.05 ÷ 10 bar
Overpressure exhaust	with relieving (standard)
Nominal flow	see FLOW DIAGRAMS on the following pages
Media	filtered and not lubricated compressed air according to DIN ISO 8573-1 Classes 1-3-2
Hysteresis	20mbar
Repeatability	±0.2% FS
Bleed air consumption	≤ 5 l/min

CODING EXAMPLE

PR	1	04	-	M	07
PR	SERIES				
1	SIZE: 1 = size 1 2 = size 2				
04	PORTS: 04 = G1/4 38 = G3/8 (size 2 only)				
M	TYPE OF ADJUSTMENT: M = manual				
07	OPERATING PRESSURE (1 bar = 14,5 psi): 02 = 0.05 ÷ 2 bar 04 = 0.05 ÷ 4 bar 07 = 0.05 ÷ 7 bar 00 = 0.05 ÷ 10 bar				

SERIES PR PRECISION REGULATORS

Series PR precision regulators - materials

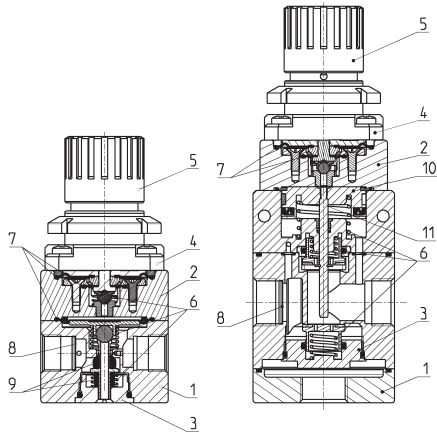

PARTS	MATERIALS
1 = Body	Anodized aluminium
2 = Intermediate body	Aluminium
3 = Valve holder plug	Brass
4 = Bell	Polyamide
5 = Regulator knob	Polyamide
6 = Springs	Stainless steel
7 = Diaphragms	NBR
8 = Filters	Stainless steel
9 = Seals	NBR
10 = Piston	Aluminium
11 = Rod	Stainless steel
O-ring	NBR

Series PR precision regulators - size 1



* to complete the code, add the OPERATING PRESSURE (see the CODING EXAMPLE)

PR02 = Regulator with relieving

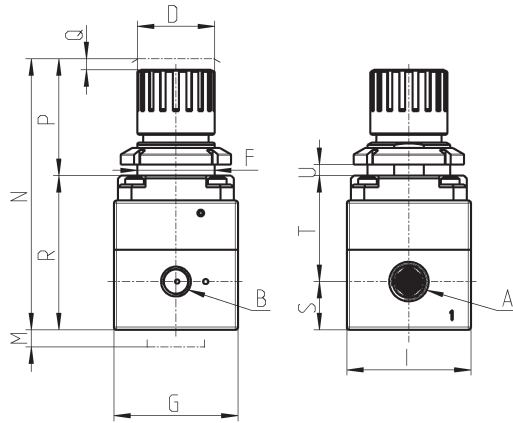
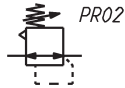

DIMENSIONS															
Mod.	A	B	D	F	G	I	M	N	P	Q	R	S	T	U	Weight (Kg)
PR104-M*	G1/4	G1/8	28	30	45	45	25	96	40	2	56	17.5	38.5	0-6	0.35

Series PR precision regulators - size 2



* to complete the code, add the OPERATING PRESSURE (see the CODING EXAMPLE)

PR02 = Regulator with relieving

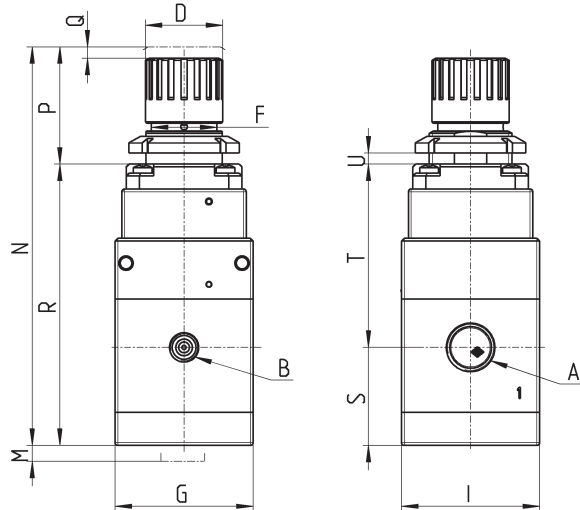

DIMENSIONS															
Mod.	A	B	D	F	G	I	M	N	P	Q	R	S	T	U	Weight (Kg)
PR204-M*	G1/4	G1/8	28	30	50	50	25	140	40	2	101.8	35.5	66.3	0-6	0.645
PR238-M*	G3/8	G1/8	28	30	50	50	25	140	40	2	101.8	35.5	66.3	0-6	0.645

FLOW DIAGRAMS Mod. PR104-M00

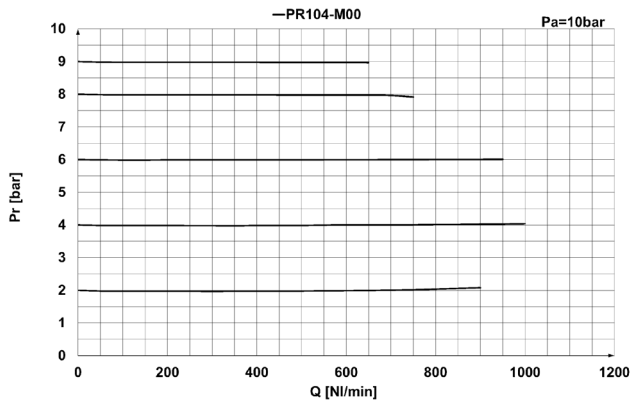

Pr = Regulated pressure (bar)
Q = Flow (NL/min)
Pa = Inlet pressure (bar)

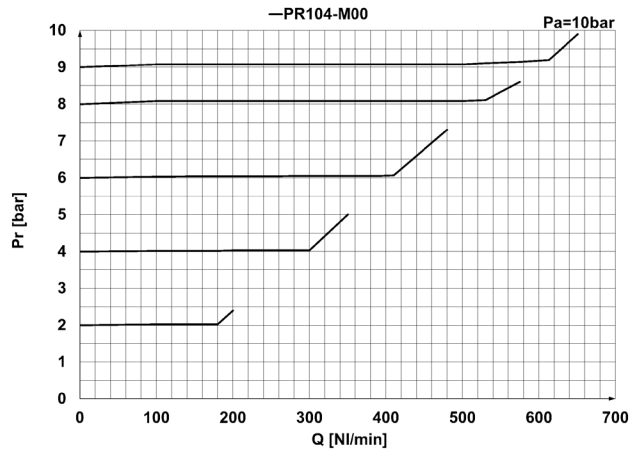

EXHAUST FLOW
Pr = Regulated pressure (bar)
Q = Flow (NL/min)
Pa = Inlet pressure (bar)

FLOW DIAGRAMS Mod. PR104-M07

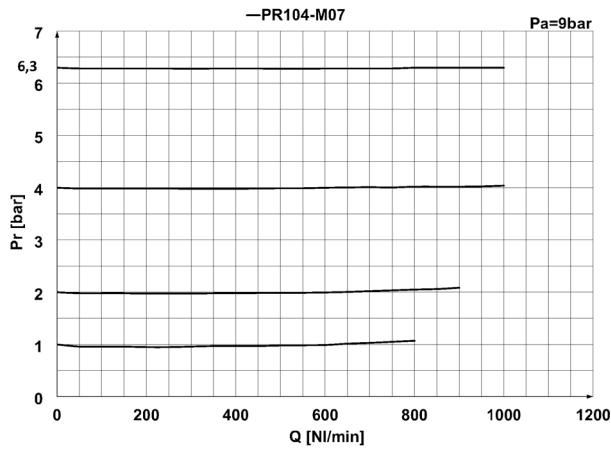

Pr = Regulated pressure (bar)
Q = Flow (NL/min)
Pa = Inlet pressure (bar)

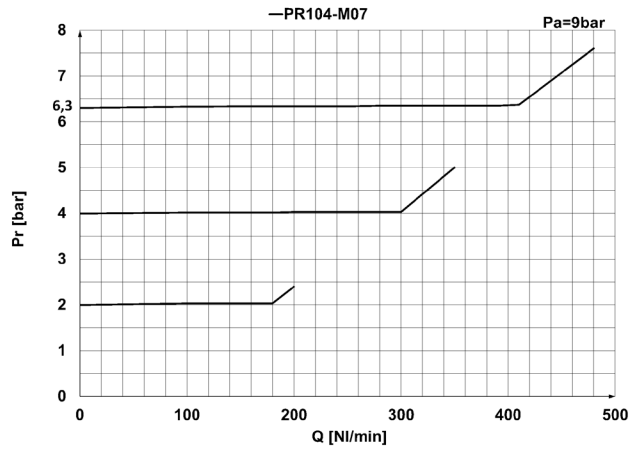

EXHAUST FLOW
Pr = Regulated pressure (bar)
Q = Flow (NL/min)
Pa = Inlet pressure (bar)

FLOW DIAGRAMS Mod. PR104-M04

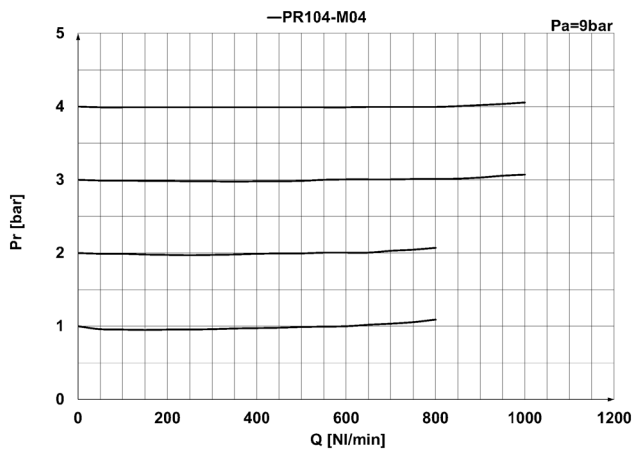

Pr = Regulated pressure (bar)
Q = Flow (NL/min)
Pa = Inlet pressure (bar)

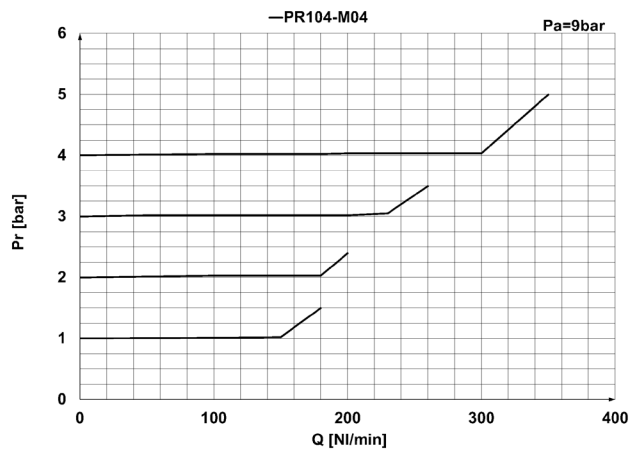

EXHAUST FLOW
Pr = Regulated pressure (bar)
Q = Flow (NL/min)
Pa = Inlet pressure (bar)

FLOW DIAGRAMS Mod. PR104-M02

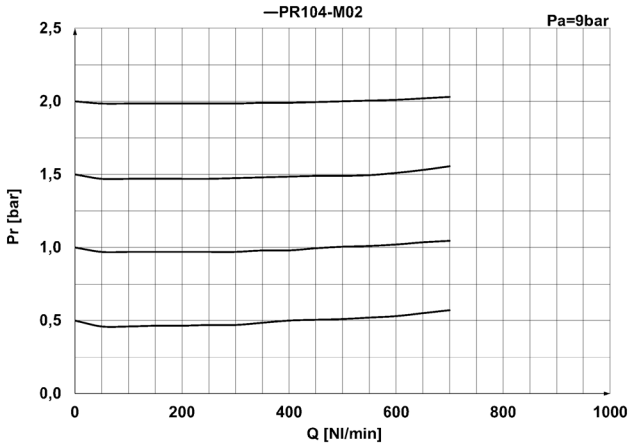

Pr = Regulated pressure (bar)
Q = Flow (NL/min)
Pa = Inlet pressure (bar)

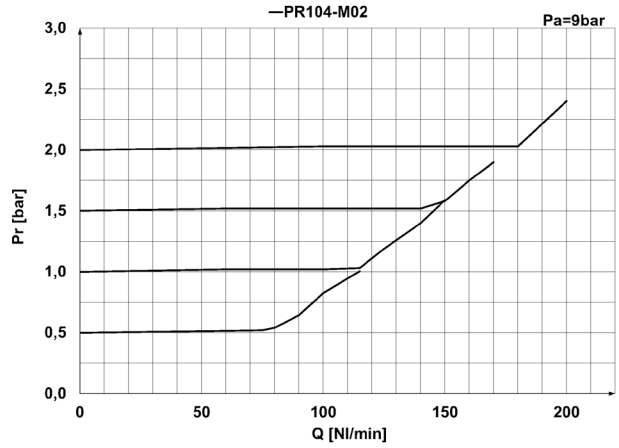

EXHAUST FLOW
Pr = Regulated pressure (bar)
Q = Flow (NL/min)
Pa = Inlet pressure (bar)

FLOW DIAGRAMS Mod. PR204-M00

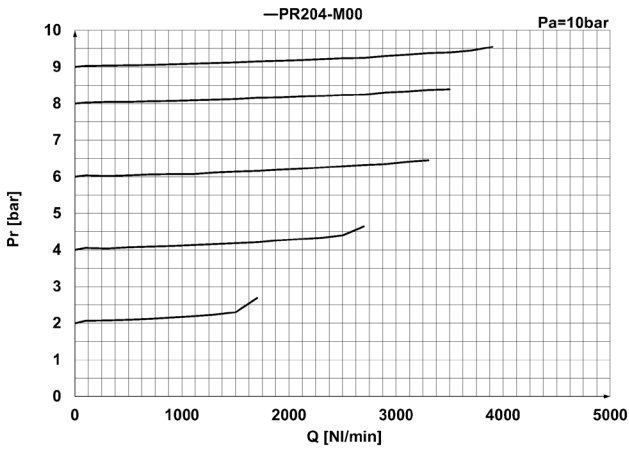

Pr = Regulated pressure (bar)
Q = Flow (NL/min)
Pa = Inlet pressure (bar)

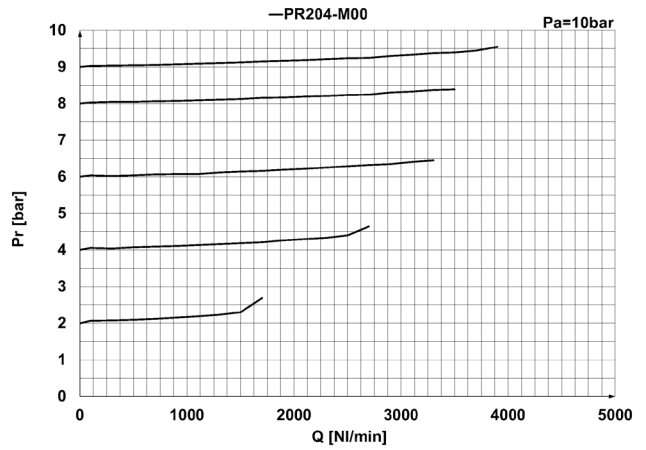

EXHAUST FLOW
Pr = Regulated pressure (bar)
Q = Flow (NL/min)
Pa = Inlet pressure (bar)

FLOW DIAGRAMS Mod. PR204-M07

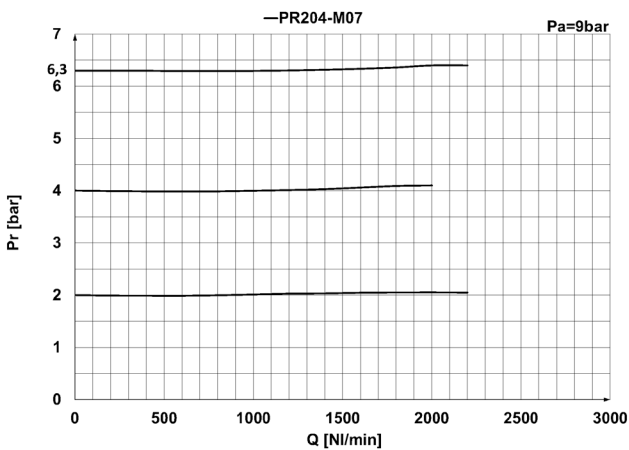

Pr = Regulated pressure (bar)
Q = Flow (NL/min)
Pa = Inlet pressure (bar)

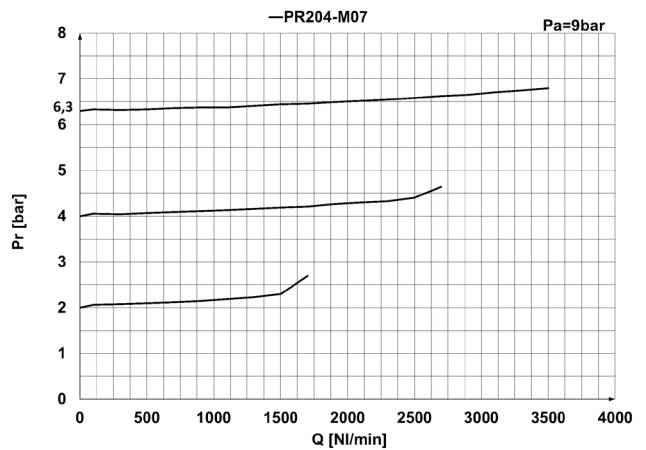

EXHAUST FLOW
Pr = Regulated pressure (bar)
Q = Flow (NL/min)
Pa = Inlet pressure (bar)

FLOW DIAGRAMS Mod. PR204-M04

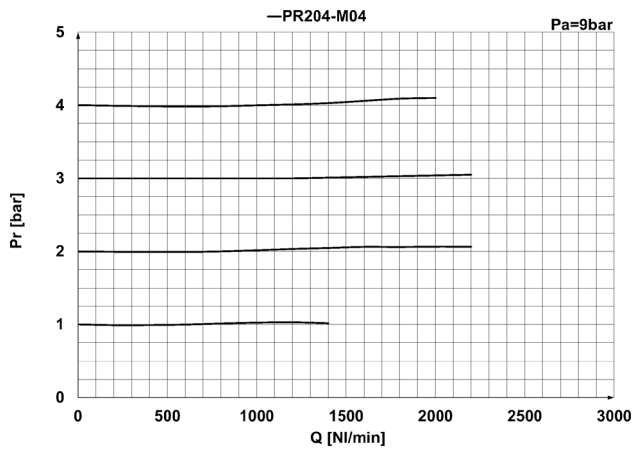

Pr = Regulated pressure (bar)
 Q = Flow (NL/min)
 Pa = Inlet pressure (bar)

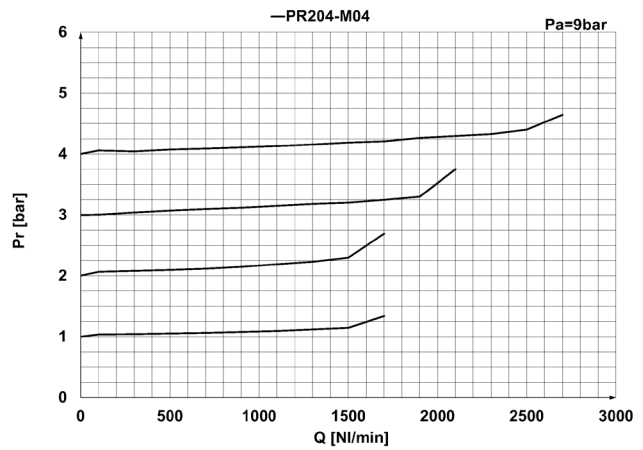

EXHAUST FLOW
 Pr = Regulated pressure (bar)
 Q = Flow (NL/min)
 Pa = Inlet pressure (bar)

FLOW DIAGRAMS Mod. PR204-M02

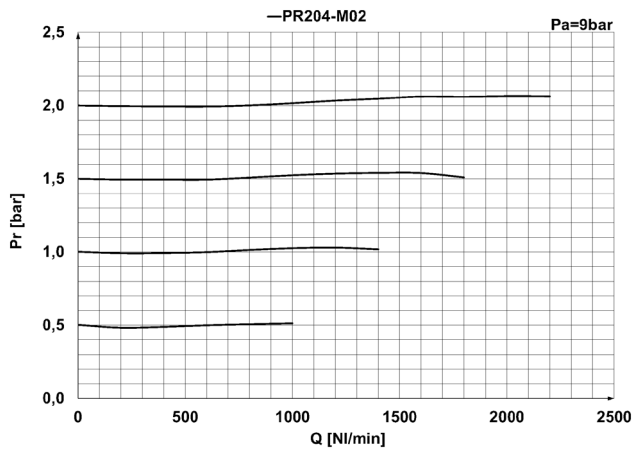

Pr = Regulated pressure (bar)
 Q = Flow (NL/min)
 Pa = Inlet pressure (bar)

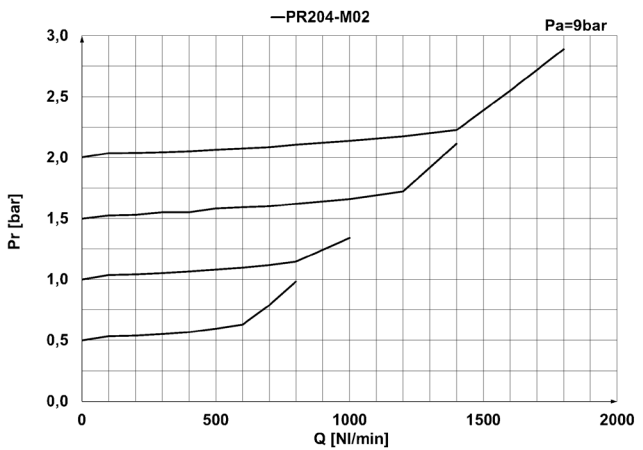

EXHAUST FLOW
 Pr = Regulated pressure (bar)
 Q = Flow (NL/min)
 Pa = Inlet pressure (bar)

FLOW DIAGRAMS Mod. PR238-M00

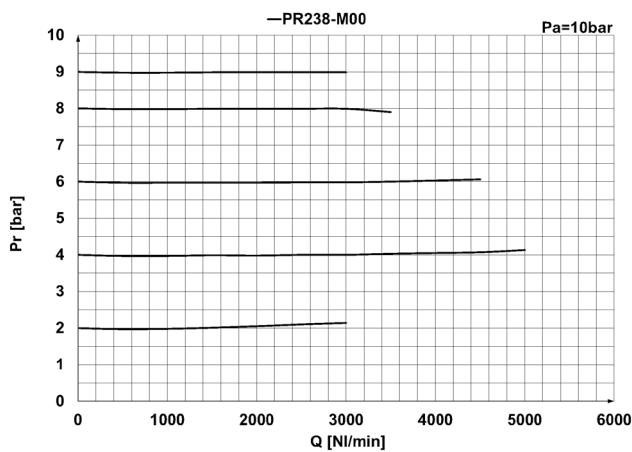

Pr = Regulated pressure (bar)
 Q = Flow (NL/min)
 Pa = Inlet pressure (bar)

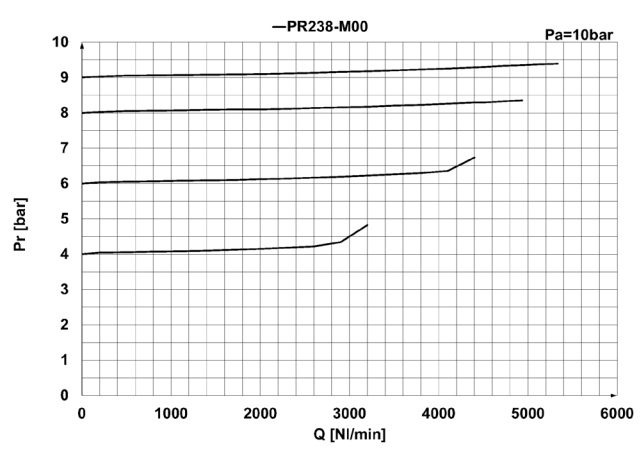

EXHAUST FLOW
 Pr = Regulated pressure (bar)
 Q = Flow (NL/min)
 Pa = Inlet pressure (bar)

FLOW DIAGRAMS Mod. PR238-M07

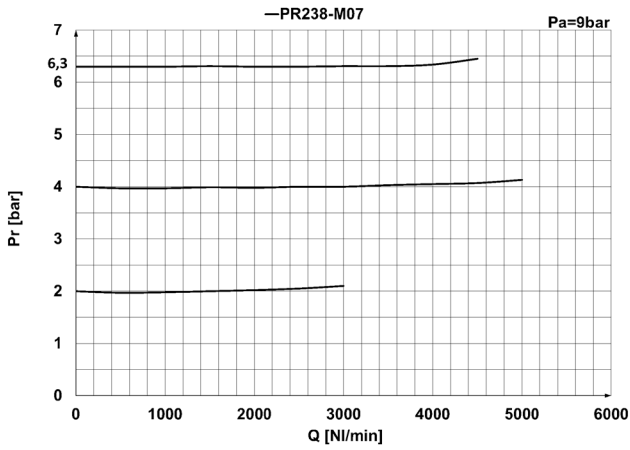

Pr = Regulated pressure (bar)
Q = Flow (NL/min)
Pa = Inlet pressure (bar)

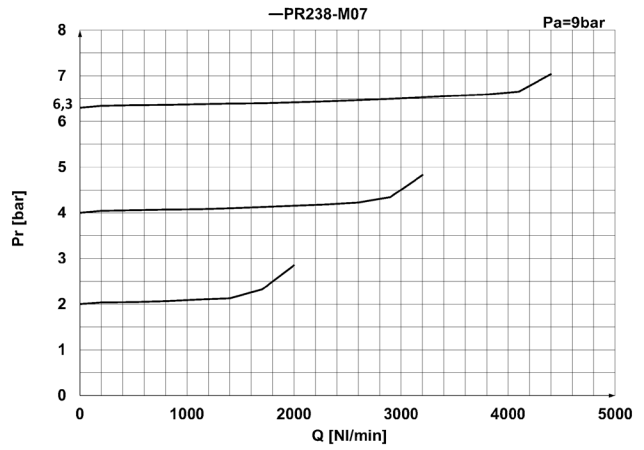

EXHAUST FLOW
Pr = Regulated pressure (bar)
Q = Flow (NL/min)
Pa = Inlet pressure (bar)

FLOW DIAGRAMS Mod. PR238-M04

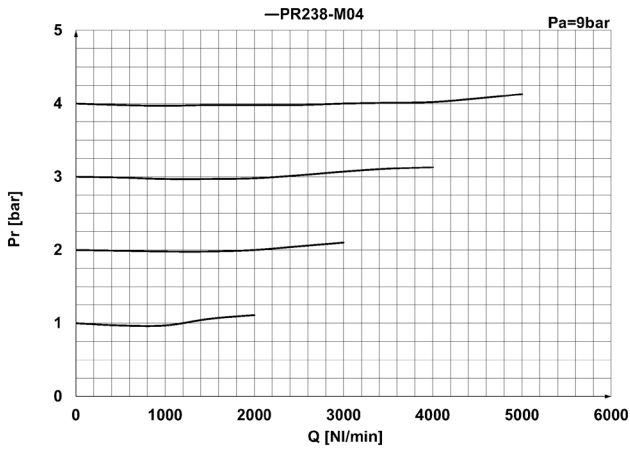

Pr = Regulated pressure (bar)
Q = Flow (NL/min)
Pa = Inlet pressure (bar)

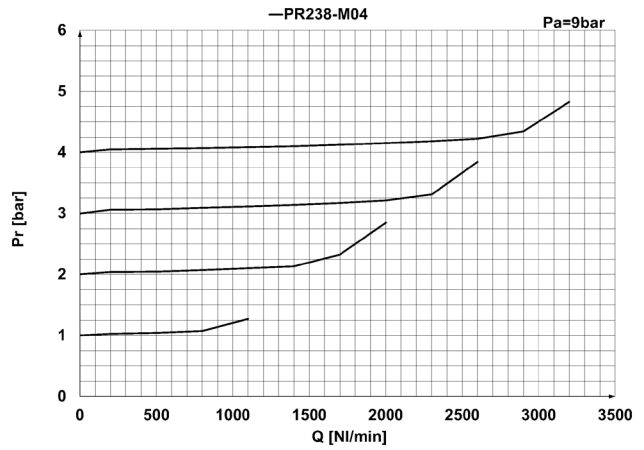

EXHAUST FLOW
Pr = Regulated pressure (bar)
Q = Flow (NL/min)
Pa = Inlet pressure (bar)

FLOW DIAGRAMS Mod. PR238-M02

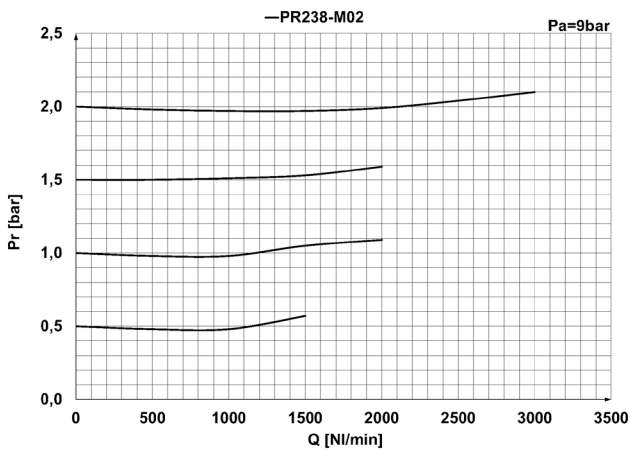

Pr = Regulated pressure (bar)
Q = Flow (NL/min)
Pa = Inlet pressure (bar)

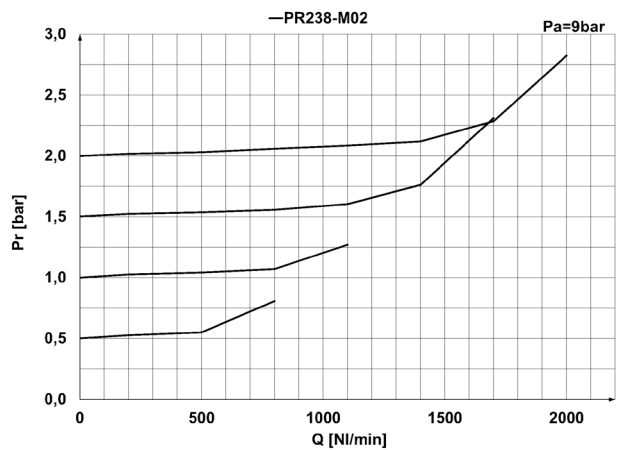

EXHAUST FLOW
Pr = Regulated pressure (bar)
Q = Flow (NL/min)
Pa = Inlet pressure (bar)